

UNI-ROYAL
厚聲集團

DATA SHEET

Product Name Complete Pb-Free Thick Film Chip Resistors

Part Name PF Series

File No. SMD-SP-013

Uniroyal Electronics Global Co., Ltd.

88#, Longteng Road, Economic & Technical Development Zone, Kunshan, Jiangsu, China

Tel +86 512 5763 1411 / 22 /33

Email marketing@uni-royal.cn

Manufacture Plant Uniroyal Electronics Industry Co., Ltd.

Aeon Technology Corporation

Royal Electronic Factory (Thailand) Co., Ltd.

Royal Technology (Thailand) Co., Ltd.

1. Scope

- 1.1 This datasheet is the characteristics of Complete Pb-Free Thick Film Chip Resistors manufactured by UNI-ROYAL
- 1.2 Total Lead-Free in Whole resistor body
- 1.3 Reduction of assembly costs and matching with placement machine
- 1.4 Suitable for both wave & re-flow soldering

2. Part No. System

Part No. includes 14 codes shown as below:

2.1 1st~4th codes: Part name. E.g.: PF0A, PF01, PF02, PF03, PF05, PF06, PF07, PF11, PF10, PF12

2.2 5th~6th codes: Power rating.

E.g.: W=Normal Size	"1~G" = "1~16"								
Wattage	1/32	3/4	1/2	1/4	1/8	1/10	1/16	1/20	1
Normal Size	WH	07	W2	W4	W8	WA	WG	WM	1W

If power rating is equal or lower than 1 watt, 5th code would be "W" and 6th code would be a number or letter.

E.g.: WA=1/10W W4=1/4W

2.3 7th code: Tolerance. E.g.: D=±0.5% F=±1% G=±2% J=±5% K= ±10%

2.4 8th~11th codes: Resistance Value.

2.4.1 If value belongs to standard value of E-24 series, the 8th code is zero, 9th~10th codes are the significant figures of resistance value, and the 11th code is the power of ten.

2.4.2 If value belongs to standard value of E-96 series, the 8th~10th codes are the significant figures of resistance value, and the 11th code is the power of ten.

2.4.3 11th codes listed as following:

0=10⁰ 1=10¹ 2=10² 3=10³ 4=10⁴ 5=10⁵ 6=10⁶ J=10⁻¹ K=10⁻² L=10⁻³ M=10⁻⁴

2.5 12th~14th codes.

2.5.1 12th code: Packaging Type. E.g.: C=Bulk T=Tape/Reel

2.5.2 13th code: Standard Packing Quantity.

4=4,000pcs 5=5,000pcs C=10,000pcs D=20,000pcs E=15,000pcs

Chip Product: BD=B/B-20000pcs TC=T/R-10000pcs

2.5.3 14th code: Special features.

E = Environmental Protection, Lead Free, or Standard type.

3. Ordering Procedure

(Example: PF02 1/16W ±5% 2.2Ω T/R-10000)

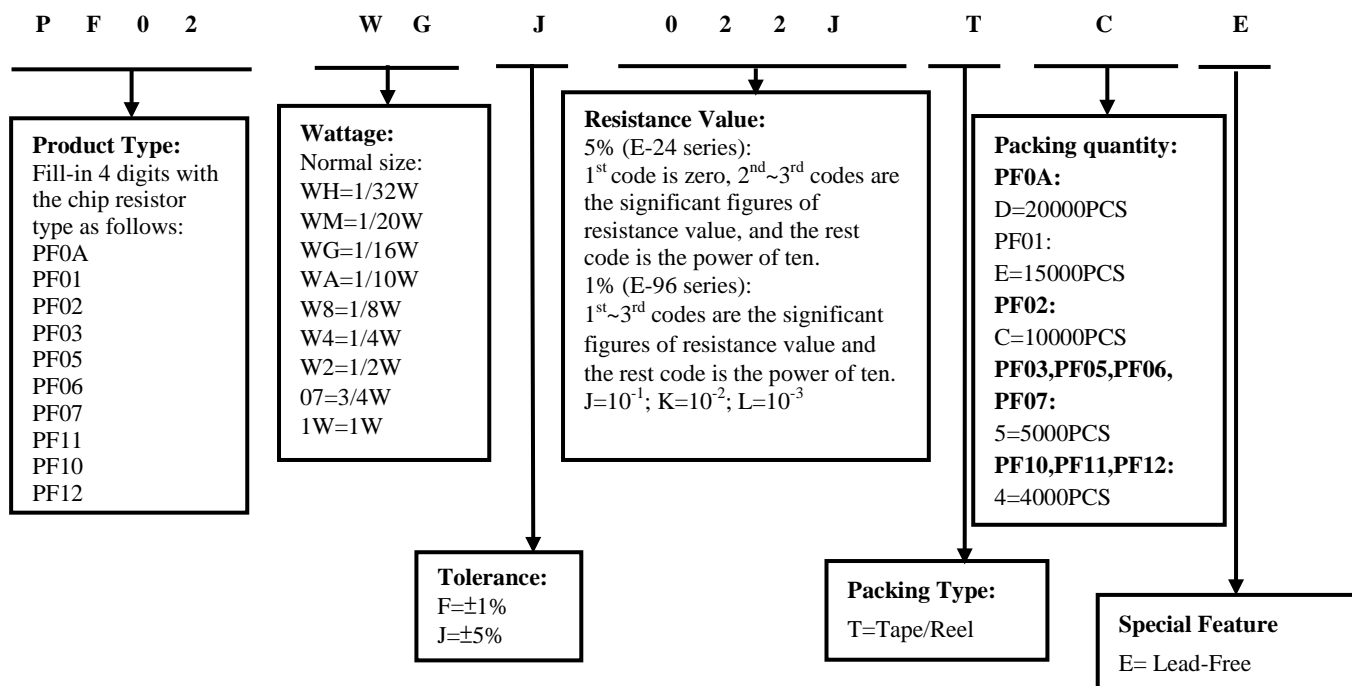

4. Marking

4.1 For PFOA、PF02 size. Due to the very small size of the resistor's body, there is no marking on the body.



4.2 Normally, the marking of 0Ω PF03, 0Ω PF05, 0Ω PF06, 0Ω PF07, 0Ω PF11, 0Ω PF10, 0Ω PF12, resistors as following



0 → 0Ω

4.3 ±5% tolerance products (E-24 series):

3 codes.

1st~2nd codes are the significant figures of resistance value, and the rest code is the power of ten.



333 → 33KΩ

4.4 ±1% tolerance products (E-96 series):

4 codes.

1st~3rd codes are the significant figures of resistance value, and the rest code is the power of ten.

Letter "R" in mark means decimal point.



2701 → 2.7KΩ

4.5 Standard E-96 series values of 0603 ≤1% : due to the small size of the resistor's body, 3 digits marking will be used to indicate the accurate resistance value by using the following multiplier & resistance code.

Multiplier Code (for 0603 ≤±1% marking)

Code	A	B	C	D	E	F	G	H	X	Y	Z
Multiplier	10 ⁰	10 ¹	10 ²	10 ³	10 ⁴	10 ⁵	10 ⁶	10 ⁷	10 ⁻¹	10 ⁻²	10 ⁻³

Standard E-96 series Resistance Value code (for 0603 ≤±1% marking)

Value	Code	Value	Code	Value	Code	Value	Code
100	01	178	25	316	49	562	73
102	02	182	26	324	50	576	74
105	03	187	27	332	51	590	75
107	04	191	28	340	52	604	76
110	05	196	29	348	53	619	77
113	06	200	30	357	54	634	78
115	07	205	31	365	55	649	79
118	08	210	32	374	56	665	80
121	09	215	33	383	57	681	81
124	10	221	34	392	58	698	82
127	11	226	35	402	59	715	83
130	12	232	36	412	60	732	84
133	13	237	37	422	61	750	85
137	14	243	38	432	62	768	86
140	15	249	39	442	63	787	87
143	16	255	40	453	64	806	88
147	17	261	41	464	65	825	89
150	18	267	42	475	66	845	90
154	19	274	43	487	67	866	91
158	20	280	44	499	68	887	92
162	21	287	45	511	69	909	93
165	22	294	46	523	70	931	94
169	23	301	47	536	71	953	95
174	24	309	48	549	72	976	96

So the resistance value are marked as the following examples



$$1.96K\Omega = 196 \times 10^1 \Omega = 29B$$



$$12.4\Omega = 124 \times 10^{-1} \Omega = 10X$$

4.6 Standard E-24 and not belong to E-96 series values ($\leq \pm 1\%$) of 0603 size: the marking is the same as 5% tolerance but marking as underline.



$$\underline{333} = 33K\Omega$$



$$\underline{680} = 68\Omega$$

5. Dimension

Type	Dimension(mm)				
	L	W	H	A	B
PF0A(01005)	0.40±0.02	0.20±0.02	0.13±0.02	0.10±0.05	0.10±0.03
PF01(0201)	0.60±0.03	0.30±0.03	0.23±0.03	0.10±0.05	0.15±0.05
PF02(0402)	1.00±0.10	0.50±0.05	0.35±0.05	0.20±0.10	0.25±0.10
PF03(0603)	1.60±0.10	0.80±0.10	0.45±0.10	0.30±0.20	0.30±0.20
PF05(0805)	2.00±0.15	1.25±0.15/-0.10	0.55±0.10	0.40±0.20	0.40±0.20
PF06(1206)	3.10±0.15	1.55±0.15/-0.10	0.55±0.10	0.45±0.20	0.45±0.20
PF07(1210)	3.10±0.10	2.60±0.20	0.55±0.10	0.50±0.25	0.50±0.20
PF11(1812)	4.50±0.20	3.20±0.20	0.55±0.20	0.50±0.20	0.50±0.20
PF10(2010)	5.00±0.10	2.50±0.20	0.55±0.10	0.60±0.25	0.50±0.20
PF12(2512)	6.35±0.10	3.20±0.20	0.55±0.10	0.60±0.25	0.50±0.20

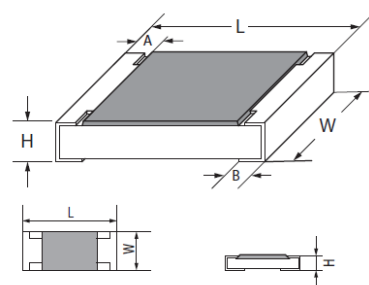

6. Resistance Range

Type	Power Rating	Max. Working Voltage	Max. Overload Voltage	Dielectric withstanding Voltage	Resistance Value of Jumper	Rated Current of Jumper	Max. Overload Current of Jumper	Resistance Range 1%	Resistance Range 5%	Operating Temperature
PF0A	1/32W	15V	30V	--	<50mΩ	0.5A	1A	10Ω~10MΩ	1Ω~10MΩ	-55°C~125°C
PF01	1/20W	25V	50V	--	<50mΩ	0.5A	1A	1Ω~10MΩ	1Ω~10MΩ	-55°C~155°C
PF02	1/16W	50V	100V	100V	<50mΩ	1A	2A	1Ω~10MΩ	1Ω~10MΩ	-55°C~155°C
PF03	1/10W	75V	150V	300V	<50mΩ	1A	2A	1Ω~10MΩ	1Ω~10MΩ	-55°C~155°C
PF05	1/8W	150V	300V	500V	<50mΩ	2A	5A	1Ω~10MΩ	1Ω~10MΩ	-55°C~155°C
PF06	1/4W	200V	400V	500V	<50mΩ	2A	10A	1Ω~10MΩ	1Ω~10MΩ	-55°C~155°C
PF07	1/2W	200V	500V	500V	<50mΩ	2A	10A	1Ω~10MΩ	1Ω~10MΩ	-55°C~155°C
PF11	3/4W	200V	500V	500V	<50mΩ	2A	10A	1Ω~10MΩ	1Ω~10MΩ	-55°C~155°C
PF10	3/4W	200V	500V	500V	<50mΩ	2A	10A	1Ω~10MΩ	1Ω~10MΩ	-55°C~155°C
PF12	1W	200V	500V	500V	<50mΩ	2A	10A	1Ω~10MΩ	1Ω~10MΩ	-55°C~155°C

7. Soldering pad size recommended

Type	Dimension(mm)			
	A	B	C	D
PF0A	0.14±0.03	0.2±0.03	0.2±0.03	0.54±0.03
PF01	0.25±0.15	0.25±0.15	0.3±0.03	1.0±0.05
PF02	0.50±0.05	0.45±0.05	0.5±0.05	1.4±0.05
PF03	0.8±0.05	0.65±0.05	0.8±0.05	2.1±0.05
PF05	1.0±0.1	1.0±0.1	1.3±0.1	3.0±0.1
PF06	2.0±0.1	1.1±0.1	1.6±0.1	4.2±0.1
PF07	2.0±0.1	1.1±0.1	2.6±0.1	4.2±0.1
PF10	3.6±0.1	1.3±0.1	2.6±0.1	6.2±0.1
PF11	3.0±0.1	1.4±0.1	3.3±0.1	5.8±0.1
PF12	4.9±0.1	1.6±0.1	3.3±0.1	8.1±0.1

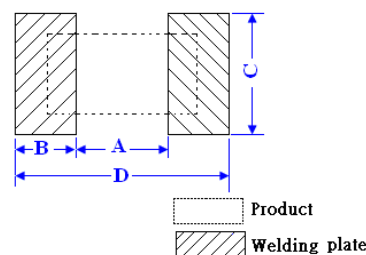

8. Derating Curve

Power rating will change based on continuous load at ambient temperature from -55 to 155°C or 125°C. It is constant between -55 to 70°C, and derate to zero when temperature rise from 70 to 155°C or 125°C.

Voltage rating:

Resistors shall have a rated direct-current (DC) continuous working voltage or an approximate sine-wave root-mean-square (RMS) alternating-current (AC) continuous working voltage at commercial-line frequency and waveform corresponding to the power rating, as determined from the following formula:

$$RCWV = \sqrt{P} \times R$$

Remark: RCWV: Rating Continuous Working Voltage (Volt.) P: power rating (Watt) R: nominal resistance (Ω)

In no case shall the rated DC or RMS AC continuous working voltage be greater than the applicable maximum value.

The overload voltage is 2.5 times RCWV or Max. Overload voltage whichever is lower.

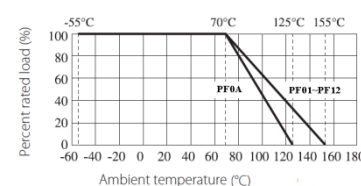

9. Structure

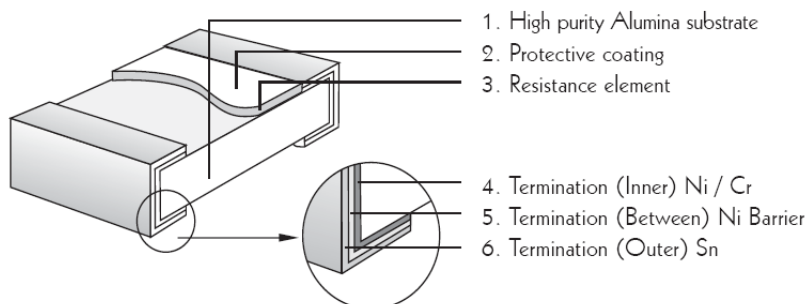

10. Performance Specification

Characteristic	Limits	Test Methods (GB/T5729&JIS-C-5201&IEC60115-1)								
◎Temperature Coefficient	PF0A: $1\Omega \leq R \leq 10\Omega$: -200~600PPM/°C $10\Omega < R \leq 100\Omega$: ±300PPM/°C $>100\Omega$: ±200PPM/°C PF01: $1\Omega \leq R \leq 10\Omega$: -100~350PPM/°C $>10\Omega$: ±200PPM/°C PF02, PF03, PF05, PF06, PF07, PF11, PF10, PF12: $1\Omega \leq R \leq 10\Omega$: ±400PPM/°C $10\Omega < R \leq 100\Omega$: ±200PPM/°C $>100\Omega$: ±100PPM/°C	4.8 Natural resistance changes per temp. Degree centigrade $\frac{R_2 - R_1}{R_1(t_2 - t_1)} \times 10^6$ (PPM/°C) R ₁ : Resistance Value at room temperature (t ₁) ; R ₂ : Resistance at test temperature (t ₂) t ₁ : +25°C or specified room temperature t ₂ : Test temperature (-55°C or 125°C)								
◎ *Short-time overload	<table border="1"> <tr> <td>±1%</td> <td>±(1.0%+0.1Ω)</td> </tr> <tr> <td>±5%</td> <td>±(2.0%+0.1Ω)</td> </tr> <tr> <td>PF0A</td> <td>±(2.0%+0.1Ω)</td> </tr> <tr> <td>* <50mΩ</td> <td></td> </tr> </table>	±1%	±(1.0%+0.1Ω)	±5%	±(2.0%+0.1Ω)	PF0A	±(2.0%+0.1Ω)	* <50mΩ		4.13 Permanent resistance change after the application of a potential of 2.5 times RCWV or Max. Overload Voltage whichever less for 5 seconds.. Apply max Overload current for 0Ω
±1%	±(1.0%+0.1Ω)									
±5%	±(2.0%+0.1Ω)									
PF0A	±(2.0%+0.1Ω)									
* <50mΩ										

* Dielectric withstanding voltage	No evidence of flashover mechanical damage, arcing or insulation breaks down.		4.7 Resistors shall be clamped in the trough of a 90°C metallic v-block and shall be tested at ac potential respectively specified in the given list of each product type for 60-70 seconds.
◎ *Solderability	Coverage must be over 95%.		4.17 The area covered with a new, smooth, clean, shiny and continuous surface free from concentrated pinholes. Temperature of solder: 245±3°C; Dwell time in solder: 2~3 seconds.
◎ Rapid change of temperature	±1%	±(0.5%+0.05Ω)	4.19 30 min at lower limit temperature and 30 min at upper limit temperature , 100 cycles.
	±5%	±(1.0%+0.05Ω)	
	PF0A	±(1.0%+0.05Ω)	
◎ Soldering heat	±(1.0%+0.05Ω)		4.18 Dip the resistor into a solder bath having a temperature of 260°C±5°C and hold it for 10±1 seconds.
Terminal bending	±(1.0%+0.05Ω)		4.33 Twist of test board: Y/X = 3/90 mm for 60Seconds
* Insulation resistance	≥1,000 MΩ		4.6 The measuring voltage shall be ,measured with a direct voltage of (100±15)V or a voltage equal to the dielectric withstanding voltage., and apply for 1min.
◎ Humidity (steady state)	±1%	±(0.5%+0.1Ω)	4.24 Temporary resistance change after 240 hours exposure in a humidity test chamber controlled at 40±2°C and 90-95% relative humidity.
	±5%	±(3.0%+0.1Ω)	
	PF0A	±(3.0%+0.1Ω)	
◎ *Load life in humidity	±1%	±(1.0%+0.1Ω)	7.9 Resistance change after 1,000 hours (1.5 hours “ON”, 0.5 hour “OFF”) at RCWV in a humidity chamber controlled at 40°C±2°C and 90 to 95% relative humidity.
	±5%	±(3.0%+0.1Ω)	
	PF0A	±(3.0%+0.1Ω)	
	* <50mΩ		Apply to rated current for 0Ω
◎ *Load life	±1%	±(1.0%+0.1Ω)	4.25.1 Permanent resistance change after 1,000 hours operating at RCWV with duty cycle 1.5 hours “ON”, 0.5 hour “OFF” at 70°C±2°C ambient.
	±5%	±(3.0%+0.1Ω)	
	PF0A	±(3.0%+0.1Ω)	
	* <50mΩ		Apply to rated current for 0Ω
◎ *Low Temperature Storage	±1%	±(1.0%+0.1Ω)	IEC 60068-2-1 (Aa) Lower limit temperature , for 2H.
	±5%	±(3.0%+0.1Ω)	
	PF0A	±(3.0%+0.1Ω)	
	* <50mΩ		
◎ *High Temperature Exposure	±1%	±(1.0%+0.1Ω)	MIL-STD-202 108A Upper limit temperature , for 1000H.
	±5%	±(3.0%+0.1Ω)	
	PF0A	±(3.0%+0.1Ω)	
	* <50mΩ		
◎ *Leaching	No visible damage		J-STD-002 Test D Samples completely immersed for 30 sec in solder bath at 260°C

The resistors of 0Ω only can do the characteristic noted of *

The resistors of 01005 & 0201 only can do the characteristic noted of ◎

11. Soldering Condition

(This is for recommendation, please customer perform adjustment according to actual application)

11.1 Recommend Reflow Soldering Profile : (solder : Sn96.5 / Ag3 / Cu0.5)

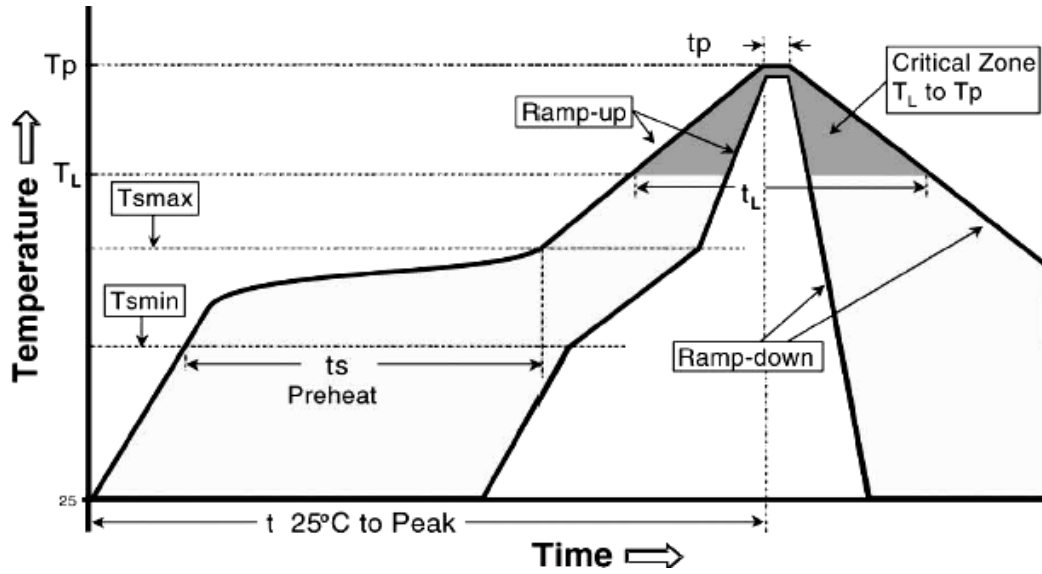

Profile Feature	Lead (Pb)-Free solder
Preheat: Temperature Min (Ts _{min}) Temperature Max (Ts _{max}) Time (Ts _{min} to Ts _{max}) (ts)	150°C 200°C 60 -120seconds
Average ramp-up rate: (Ts max to Tp)	3°C / second max.
Time maintained above : Temperature (TL) Time (tL)	217°C 60-150 seconds
Peak Temperature (Tp)	260°C
Time within $\begin{matrix} +0 \\ -5 \end{matrix}$ °C of actual peak Temperature (tp) ²	10 seconds
Ramp-down Rate	6°C/second max.
Time 25°C to Peak Temperature	8minutes max.

Allowed Re-flow times : 2 times

Remark : To avoid discoloration phenomena of chip on terminal electrodes, please use N2 Re-flow furnace .

11.2 Recommend Wave Soldering Profile : (Apply to 0603 and above size)

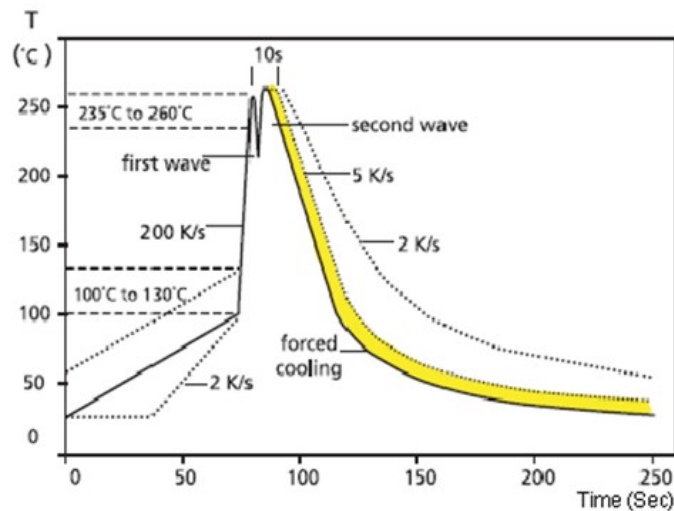

12. Packing

12.1 Dimension of Paper Taping :(Unit: mm)

Type	A	B	C ±0.05	$\Phi D_{-0}^{+0.1}$	E ±0.1	F ±0.05	G ±0.1	W ±0.2	T ±0.1
PF0A	0.24±0.05	0.45±0.05	2.00	1.50	1.75	3.50	4.00	8.00	0.40±0.1
PF01	0.40±0.05	0.70±0.05	2.00	1.50	1.75	3.50	4.00	8.00	0.42±0.1
PF02	0.65±0.10	1.20±0.10	2.00	1.50	1.75	3.50	4.00	8.00	0.42±0.05

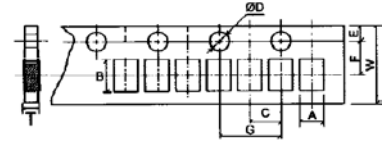

Type	A ±0.2	B ±0.2	C ±0.05	$\Phi D_{-0}^{+0.1}$	E ±0.1	F ±0.05	G ±0.1	W ±0.2	T ±0.1
PF03	1.10	1.90	2.00	1.50	1.75	3.50	4.00	8.00	0.67
PF05	1.65	2.40	2.00	1.50	1.75	3.50	4.00	8.00	0.81
PF06	2.00	3.60	2.00	1.50	1.75	3.50	4.00	8.00	0.81
PF07	2.80	3.50	2.00	1.50	1.75	3.50	4.00	8.00	0.75

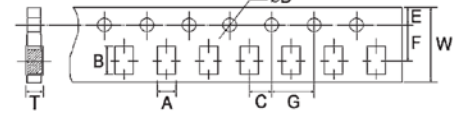

12.2 Dimension of plastic taping: (Unit: mm)

Type	A ±0.2	B ±0.2	C ±0.05	$\Phi D_{-0}^{+0.1}$	$\Phi D_{-0}^{+0.25}$	E ±0.1	F ±0.05	G ±0.1	W ±0.2	T ±0.1
PF10	2.90	5.60	2.00	1.50	1.50	1.75	5.50	4.00	12.00	1.00
PF11	3.50	4.80	2.00	1.50	1.50	1.75	5.50	4.00	12.00	1.00
PF12	3.50	6.70	2.00	1.50	1.50	1.75	5.50	4.00	12.00	1.00

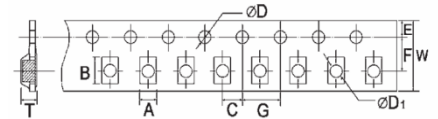

12.3 Dimension of Reel: (Unit: mm)

Type	Taping	Qty/Reel	A ±0.5	B ±0.5	C ±0.5	D ±1	M ±2	W ±1
PF0A	Paper	20,000pcs	2.0	13.0	21.0	60.0	178.0	10.0
PF01	Paper	15,000pcs	2.0	13.0	21.0	60.0	178.0	10.0
PF02	Paper	10,000pcs	2.0	13.0	21.0	60.0	178.0	10.0
PF03	Paper	5,000pcs	2.0	13.0	21.0	60.0	178.0	10.0
PF05	Paper	5,000pcs	2.0	13.0	21.0	60.0	178.0	10.0
PF06	Paper	5,000pcs	2.0	13.0	21.0	60.0	178.0	10.0
PF07	Paper	5,000pcs	2.0	13.0	21.0	60.0	178.0	10.0
PF10	Embossed	4,000pcs	2.0	13.0	21.0	60.0	178.0	13.8
PF11	Embossed	4,000pcs	2.0	13.0	21.0	60.0	178.0	13.8
PF12	Embossed	4,000pcs	2.0	13.0	21.0	60.0	178.0	13.8

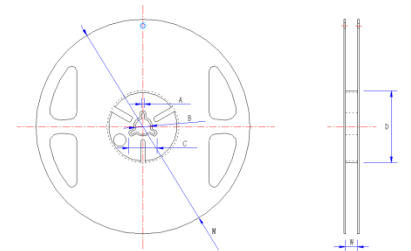

13. Note

13.1. UNI-ROYAL recommend products store in warehouse with temperature between 15 to 35°C under humidity between 25 to 75%RH.

Even under storage conditions recommended above, solder ability of products will be degraded stored over 1 year old.

13.2. Cartons must be placed in correct direction which indicated on carton, otherwise the reel or wire will be deformed.

13.3. Storage conditions as below are inappropriate:

- Stored in high electrostatic environment
- Stored in direct sunshine, rain, snow or condensation.
- Exposed to sea wind or corrosive gases, such as Cl₂, H₂S, NH₃, SO₂, NO₂, Br etc.

14. Record

Version	Description	Page	Date	Amended by	Checked by
1	First version	1~8	Mar.20, 2018	Haiyan Chen	Nana Chen
2	Modify PF01 packing quantity	8	Jun.06, 2018	Haiyan Chen	Nana Chen
3	Modify characteristic	4~5	Feb.14, 2019	Haiyan Chen	Yuhua Xu
4	Modify the High Temperature Exposure conditions	7	July.29, 2019	Haiyan Chen	Yuhua Xu
5	Modify the reflow curve and add the wave soldering curve	6	Apr.29, 2020	Haiyan Chen	Yuhua Xu
6	Add 0603 Marking	3~4	Apr.29, 2020	Song Nie	Haiyan Chen
7	Modify the temperature coefficient test conditions	5	Oct.26, 2022	Haiyan Chen	Yuhua Xu